

USER GUIDE  
UGH031-0209

# EarthSmart™

## ECM Series, 0.50 to 0.75 ton models



Please record your equipment's model and serial number(s) and the date you received it in the spaces provided.

It's a good idea to record the model and serial number(s) of your equipment and the date you received it in the User Guide. Our service department uses this information, along with the manual number, to provide help for the specific equipment you installed.

Please keep this User Guide and all manuals, engineering prints and parts lists together for documentation of your equipment.

Date:

Manual Number: UGH031-0209

Serial Number(s):

Model Number(s):

**DISCLAIMER:** The Conair Group, Inc., shall not be liable for errors contained in this User Guide or for incidental, consequential damages in connection with the furnishing, performance or use of this information. Conair makes no warranty of any kind with regard to this information, including, but not limited to the implied warranties of merchantability and fitness for a particular purpose.

# Table of Contents

## 1-1 Introduction

Purpose of the user guide . . . . .	1-2
How the guide is organized . . . . .	1-2
Your responsibilities as a user . . . . .	1-3
ATTENTION: Read this so no one gets hurt . . . . .	1-4

## 2-1 Description

What is the EarthSmart ECM Series Chiller? . . . . .	2-2
Typical applications . . . . .	2-2
Limitations . . . . .	2-3
How it works: Process circulation . . . . .	2-4
Refrigeration circulation . . . . .	2-5
Component listing . . . . .	2-6
Specifications: EarthSmart ECM Series Chiller . . . . .	2-8
Pump curve: EarthSmart ECM Series Chiller . . . . .	2-9

## 3-1 Installation

Unpacking the boxes . . . . .	3-2
Warning and cautions . . . . .	3-3
Preparing for installation . . . . .	3-4
Making process plumbing connections . . . . .	3-5
Filling the chiller . . . . .	3-6
Drain connection . . . . .	3-7
Checking the refrigerant charge . . . . .	3-8
Connecting the main power . . . . .	3-9

## 4-1 Operation

EarthSmart ECM Series Chiller: Control descriptions . . . . .	4-2
Starting the chiller . . . . .	4-3

Stopping the chiller . . . . .	4-4
Changing temperature units . . . . .	4-5
Chiller operation sequence . . . . .	4-6
Resetting the high pressure switch of the compressor . . . . .	4-8

## 5-1 Maintenance

Preventative maintenance schedule . . . . .	5-2
Checking electrical connections . . . . .	5-4
Cleaning the brazed plate adapter . . . . .	5-5
Cleaning the air-cooled condenser . . . . .	5-7
Checking the reservoir level . . . . .	5-9
Cleaning the pump strainer . . . . .	5-10
Checking the refrigerant charge and quality . . . . .	5-12

## 6-1 Troubleshooting

Before beginning . . . . .	6-2
A few words of caution . . . . .	6-3
<u>DIAGNOSTICS</u>	
How to identify the cause of a problem . . . . .	6-3
Alarms . . . . .	6-4
Troubleshooting . . . . .	6-5
Checking or replacing the temperature sensor . . . . .	6-8
Checking or resetting the circuit breakers . . . . .	6-9

## A Appendix

We're here to help . . . . .	A-1
How to contact customer service . . . . .	A-1
Before you call... . . . . .	A-1
Equipment guarantee . . . . .	A-2
Performance warranty . . . . .	A-2
Warranty limitations . . . . .	A-2

<b>B</b>	<b>Appendix</b>	
	Safety adjustments . . . . .	B-1
<b>C</b>	<b>Appendix</b>	
	Water quality control . . . . .	C-1
<b>D</b>	<b>Appendix</b>	
	Chiller capacity and derate chart . . . . .	D-1
<b>E</b>	<b>Appendix</b>	
	Pressure-temperature chart for R-134A refrigerant . . . . .	E-1
<b>F</b>	<b>Appendix</b>	
	RTD resistance chart . . . . .	F-1
<b>G</b>	<b>Appendix</b>	
	Overhead plumbing details . . . . .	G-1
<b>H</b>	<b>Appendix</b>	
	Electrical schematic . . . . .	H-1
<b>I</b>	<b>Appendix</b>	
	Control Setup . . . . .	I-1
<b>J</b>	<b>Appendix</b>	
	Plumbing schematic . . . . .	J-1



# Introduction

---

Purpose of the user guide. . . . . 1-2  
How the guide is organized. . . . . 1-2  
Your responsibilities as a user. . . . . 1-3  
ATTENTION: Read this so no one gets hurt. . . 1-4

## Purpose of the User Guide

This User Guide describes the EarthSmart ECM Series Chiller and explains step-by-step how to install, operate, maintain and repair this equipment.

Before installing this product, please take a few moments to read the User Guide and review the diagrams and safety information in the instruction packet. You also should review manuals covering associated equipment in your system. This review won't take long, and it could save you valuable installation and operating time later.

## How the Guide is Organized

Symbols have been used to help organize the User Guide and call your attention to important information regarding safe installation and operation.



Symbols within triangles warn of conditions that could be hazardous to users or could damage equipment. Read and take precautions before proceeding.



Numbers indicate tasks or steps to be performed by the user.



A diamond indicates the equipment's response to an action performed by the user.



An open box marks items in a checklist.



A circle marks items in a list.



Indicates a tip. A tip is used to provide you with a suggestion that will help you with the maintenance and the operation of this equipment.



Indicates a note. A note is used to provide additional information about the steps you are following throughout the manual.



## Your Responsibility as a User

You must be familiar with all safety procedures concerning installation, operation and maintenance of this equipment. Responsible safety procedures include:

- Thorough review of this User Guide, paying particular attention to hazard warnings, appendices and related diagrams.
- Thorough review of the equipment itself, with careful attention to voltage sources, intended use and warning labels.
- Thorough review of instruction manuals for associated equipment.
- Step-by-step adherence to instructions outlined in this User Guide.

## ATTENTION:

### Read this so no one gets hurt

We design equipment with the user's safety in mind. You can avoid the potential hazards identified on this machine by following the procedures outlined below and elsewhere in the User Guide.



**WARNING: Improper installation, operation or servicing may result in equipment damage or personal injury.**

This equipment should be installed, adjusted and serviced by a qualified technician who is familiar with the construction, operation and potential hazards of this type of machine.

All wiring, disconnects and fuses should be installed by a qualified electrical technician in accordance with electrical codes in your region. Always maintain a safe ground. Do not operate the equipment at power levels other than what is specified on the machine serial tag and data plate.



**WARNING: Voltage hazard**

This equipment is powered by single-phase alternating current, as specified on the machine serial tag and data plate.

A properly-sized conductive ground wire from the incoming power supply must be provided. Improper grounding can result in severe personal injury and erratic machine operation. (Units are supplied with a grounded plug that **must** be plugged into a grounded out.)

Always disconnect and lock out the incoming main power source before opening the electrical enclosure or performing non-standard operating procedures, such as routine maintenance. Only a qualified technician should perform troubleshooting procedures that require access to the electrical enclosure while power is on.

## ATTENTION:

### Read this so no one gets hurt (continued)



#### **CAUTION: Hot Surfaces**

Always protect yourself from hot surfaces when working on the chiller, especially when working on or around the compressor and condenser. These devices can be over 160°F {71°C}. Allow these devices to cool before performing any maintenance or troubleshooting.



#### **WARNING: Refrigerant hazard**

Only certified refrigerant technicians should examine and correct problems involving the refrigerant circuit.



## Description

---

What is the EarthSmart ECM Series Chiller? . . .	2-2
Typical applications . . . . .	2-2
Limitations . . . . .	2-3
How it works: Process circulation . . . . .	2-4
Refrigeration circulation . . . . .	2-5
Component listing . . . . .	2-6
Specifications: EarthSmart ECM	
Series Chillers . . . . .	2-8
Pump curve: EarthSmart ECM	
Series Chillers . . . . .	2-9

# What is the EarthSmart ECM Series Chiller?

 **NOTE:** Chiller's environment and cooling temperatures below the default cooling ranges will affect cooling capacities.

The Conair EarthSmart ECM Series Chillers provide self-contained sources of chilled water and are available with compressor ranges of 0.5 Hp or 0.75 Hp (nominal capacities of 0.41 tons or 0.70 tons of refrigeration).

**IMPORTANT:** Nominal chilling capacities are based on 95°F {35°C} ambient air conditions and processing 50°F {10°C} leaving water.

ECM Series Chillers are designed to provide chilled fluid for industrial applications requiring 24-hour-a-day performance. Units are totally self-contained for easy, economical installation. All parts wetted by the process are non-ferrous.

## Typical Applications

ECM Series Chillers can be used anywhere a reliable source of process cooling water at temperatures ranging from 45° to 65°F {7.2°C to 18.3°C} is required. These chillers at full load, will discharge approximately 7,500 or 12,500 BTU/hr of heat into the atmosphere (depending on model).

Chillers are available for:

- Injection molding
- Blow molding
- Thermoforming
- Extrusion
- Air compressors
- Metal plating
- Dryer intercoolers/aftercoolers
- Heatset/web offset printing presses
- Degreasing
- Laser
- Anodizing

## Limitations

Conair EarthSmart ECM Series Chillers are chosen based on the cooling load, ambient temperature and cooling temperature.

- **Cooling load** - Choose a chiller that has 0 - 10% more cooling capacity than the process load to be chilled.
- **Ambient temperature** - The chiller's air-cooled condenser requires an ambient air temperature between 40° to 95°F {4.4° to 35°C} for efficient operation. Operation above 95°F {35°C} may result in elevated condensing pressures and will eventually cause the chiller to shut down due to a high pressure safety switch. Contact Conair Service for information for operating within ambient air temperatures above 95°F {35°C} or below 40°F {4.4.°C}.
- **Temperature** - As standard, ECM Series Chillers can provide cooling temperature ranges of 45°F to 65°F {7.2°C to 18.3°C}. For cooling temperatures below 45°F {7.2°C}, contact Conair Service.

Use this information as a general guide. Consult your Conair representative for assistance when choosing a Conair EarthSmart ECM Series Chiller.

## How it Works: Process Circulation

(Left-side as viewed from the control)

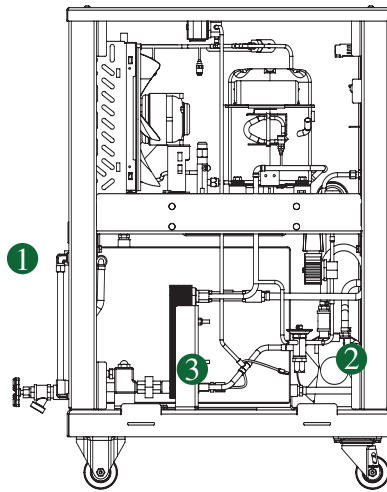

- 1 Hot fluid from the process enters the chiller through the **“From Process”** inlet into the chiller’s reservoir.
- 2 Pump moves fluid from the reservoir through evaporator where it is chilled.
- 3 Fluid is chilled in the evaporator and exits through the **“To Process”** outlet, returning to the process.



# How it Works: Refrigerant Circulation

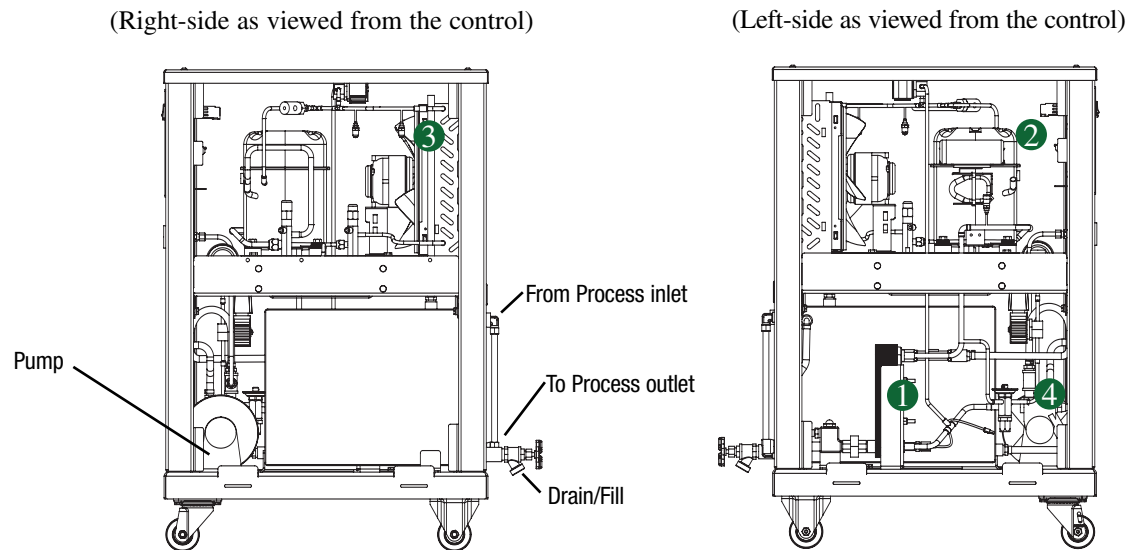

- 1 The evaporator extracts heat from the process fluid, causing the refrigerant to vaporize (evaporate) into a gas.
- 2 Vaporized refrigerant travels to the compressor, where the low-pressure vapor is compressed into a high-pressure, high-temperature vapor.
- 3 The high-pressure, high-temperature vapor travels from the compressor through the condenser, where the fan cools and condenses the vapor into a high-pressure, high-temperature liquid.
- 4 High-pressure, high-temperature liquid is metered back to the evaporator by the expansion valve (TXV), changing it to a low-pressure, low-temperature vapor.

# How it Works: Component Listing

## Water system

- **Motor/Pump assembly** - The motor/pump assembly circulates chilled coolant through the process loop. The pump assembly is built with brass to maintain water quality.

## Refrigeration system

- **Compressor** - Hermetic compressor takes low-pressure, low-temperature refrigerant gas and compresses the gas into high-pressure, high-temperature vapor.
- **Air-cooled condenser** - The air-cooled condenser removes heat BTUs from the compressor refrigerant gas. The action causes the gas to “condense” into a liquid state still under high pressure. Air flow across the condenser is achieved by a motor driven fan.
- **Fan cycling switch** - The fan cycling switch is adjustable when the chiller is in an environment cooler than 95°F {35°C}. *See Appendix J entitled, Plumbing Schematic.*
- **Filter-dryer** - The filter-drier removes contaminants and moisture from the liquid refrigerant.
- **Liquid receiver** - Serves as a collection tank for high-pressure liquid refrigerant to ensure total charge at all times.
- **Refrigerant sight glass** - The refrigerant sight glass indicates refrigerant charge and moisture content. Refrigerant charge is determined by a clear liquid flow. Bubbles indicate low refrigerant. Moisture content is indicated by the color of the sight glass view port element. The element’s color is normally green. If the color of the element is dark brown or yellow, the system has been contaminated with moisture and the refrigerant circuit needs to be serviced by a qualified refrigerant service technician. *See Maintenance section entitled, Checking the Refrigerant Charge and Quality.*
- **Expansion valve** - The expansion valve meters flow of liquid refrigerant into the evaporator and creates a pressure drop in the refrigerant system that allows the liquid refrigerant to “boil off” inside the evaporator.

## How it Works: Component Listing (continued)

- **Evaporator** - The evaporator is a brazed plate heat exchanger where the liquid refrigerant is allowed to evaporate (boil off) to absorb the heat (BTU) from the process fluid. As the heat is absorbed, the process fluid is chilled.
- **High/Low Pressure Switches:** The high/low pressure switches protect the refrigeration system from unsafe operating levels. The **high pressure switch** is factory set to open at 230 PSI and protects the refrigeration components and personnel from potential damage or injury from excessively high pressure. The high pressure safety must not be altered in the field for any reason. The **low pressure switch** is factory set to open at 25 PSI and to close at 35 PSI. The low pressure switch protects the chillers from possible damage due to low operating pressure. The low pressure switch is field adjustable for setpoints below 45°F {7.2°C}, contact a Conair representative for more information.

**IMPORTANT:** Altering the High Pressure Switch setting **will** void any chiller warranty.

 **NOTE:** The fan cycling switch is adjustable when the chiller is in an environment cooler than 95°F {35°C}. See [Appendix J entitled, Plumbing Schematic](#).

# Specifications: EarthSmart™ ECM Series Chillers

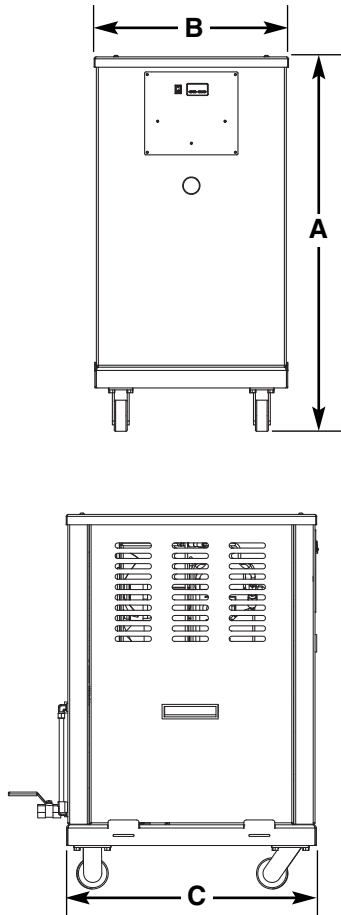

MODEL	ECM-0.5	ECM-0.75
<b>Performance characteristics</b>		
Capacity* tons	0.41	0.70
Compressor Hp {kW}†	0.5 {0.37}	0.75 {0.56}
Pump Hp {kW}	0.25 {0.19}	0.5 {0.37}
Chilled water flow‡ gpm {lpm}	0.9 {3.4}	1.7 {6.4}
Chilled water pressure‡ psi {bar}	60 {4.1}	60 {4.1}
Reservoir capacity gal {liters}	10 {37.8}	10 {37.8}
<b>Dimensions inches {mm}</b>		
A - Height	39.7 {1008}	39.7 {1008}
B - Width	18.7 {475}	18.7 {475}
C - Depth	24.2 {615}	24.2 {615}
<b>Process connections inches {mm}</b>		
Process (to and from)	0.5	0.5
<b>Weight lb {kg}§</b>		
Installed	223 {101}	233 {106}
Shipping	170 {77}	180 {82}
<b>Voltages full load amps**</b>		
115V/1 phase/60Hz	14	NA
220V/1 phase/60Hz	NA	11
<b>Refrigerant</b>		
	R-134A	
<b>Refrigerant charge lb {kg}</b>		
	1.3 {0.6}	1.3 {0.6}

## SPECIFICATION NOTES:

\* Ton capacity at 12,000 BTU/ton @ 50°F {10°C} leaving water temperature @ 115°F {46°C} condensing temperature. Capacities may be ± 5% as reserved by the compressor manufacturer. Capacity multipliers are: 50°F {10°C} - 1.00; 40°F {4.4°C} - 0.80.

† The ECM Series Chiller uses a hermetic reciprocating compressor.

‡ Consult pump curve for exact characteristics relating to pump performances.

§ Chiller installed weight includes a completely filled reservoir.

\*\* No allowance for inrush current. Ground fault interruption to be supplied by the customer. Full load amps must be used to size supply conductors. Consult a Conair representative for 50 Hz operation.

Specifications can change at any time. Contact your Conair representative for the most current information.

# Pump Curve: EarthSmart™ ECM Series Chillers

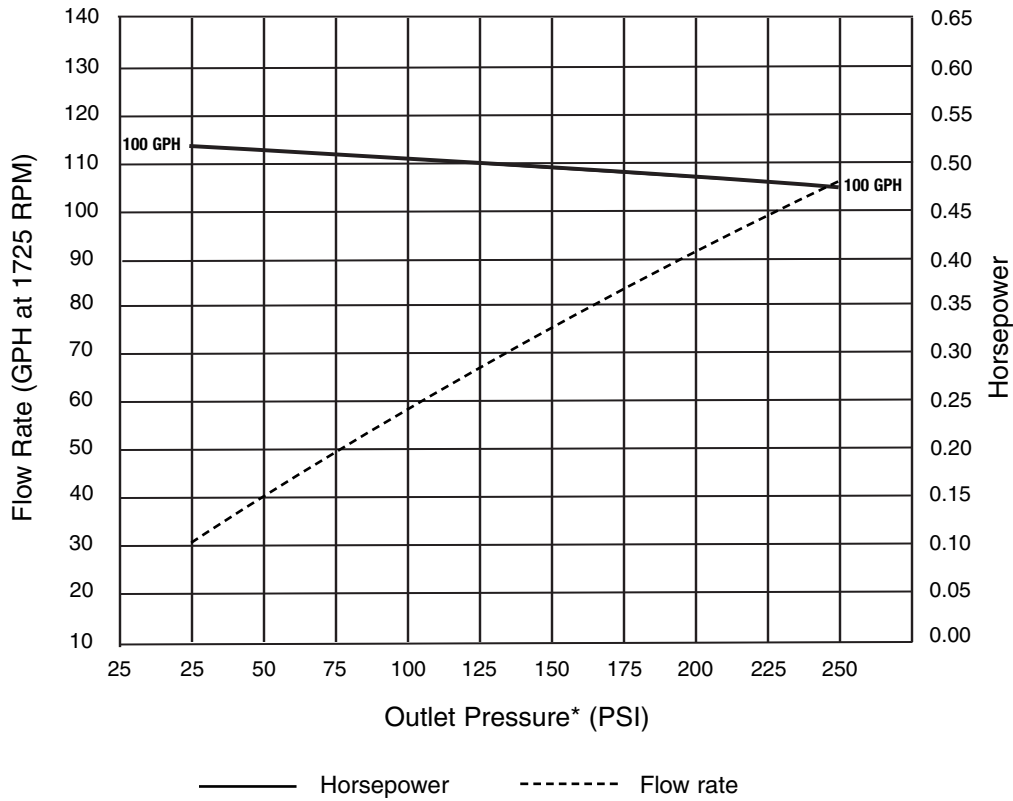

Description 2

**SPECIFICATION NOTES**

\* Pump curves do not reflect pressure drops due to internal piping.

This pump curve is non-overloading using the service factor of the motors.

Specifications may change without notice. Check with your Conair representative for the most current information.



# Installation

---

Unpacking the boxes . . . . .	3-2
Warnings and cautions . . . . .	3-3
Preparing for installation . . . . .	3-4
Making process plumbing connections . . . . .	3-5
Filling the chiller . . . . .	3-6
Drain connection . . . . .	3-7
Checking the refrigerant charge . . . . .	3-8
Connecting the main power . . . . .	3-9

# Unpacking the Boxes

The EarthSmart ECM Series Chiller comes fully assembled in a single crate. Units are shipped with the casters attached.



## **CAUTION: Lifting**

Conair EarthSmart ECM Series Chillers are designed to easily roll on casters. If, for some reason you need to lift the chiller, take all precautions to avoid personal injury or damage to the chiller. Lift the chiller using a forklift or hoist with straps that have been positioned at the chiller's center of gravity. Do not try to lift the chiller manually.

- 1 Carefully uncrate the chiller** and its components.
- 2 Remove all packing material**, protective paper, tape and plastic. Compare contents to the shipping papers to ensure that you have all the parts.
- 3 Carefully inspect all components** to ensure no damage occurred during shipping. If any damage is found, notify the shipping agent immediately to file a claim. Check all wire terminal connections, bolts and any other electrical connections, which may have come loose during shipping. Check for pinched wires and kinked hoses.
- 4 Cut the bands holding the chiller onto the pallet.**
- 5 Record serial numbers and specifications** for the chiller in the blanks provided on the back of this User Guide's title page. This information will be helpful if you ever need service or parts.



## Warnings and Cautions



**WARNING: Improper installation, operation, or servicing may result in equipment damage or personal injury.**

This equipment should only be installed, adjusted and serviced by a qualified technician who is familiar with the construction, operation and potential hazards of this type of machine.

All wiring, disconnects and fuses should be installed by a qualified electrical technician in accordance with electrical codes in your region. Always maintain a safe ground. Do not operate this equipment at power levels other than what is specified on the machine data plate.



**CAUTION: Hot Surfaces**

Always protect yourself from hot surfaces when working on the chiller, especially when working on or around the compressor and condenser. These devices can over 160°F {71°C}. Allow these devices to cool before performing any maintenance or troubleshooting.



**CAUTION: Ventilation**

The unit requires a clean and well ventilated operating environment. Do not place anything on top of the unit while operating.

Units require enough clearance around the perimeter for access panels to be removed completely. Units require a minimum of 2 ft {0.6 m} clearance around the perimeter for proper air flow.



**WARNING: Refrigerant hazard**

Only certified refrigerant technicians should examine and correct problems involving the refrigerant circuit.

# Preparing for Installation

Plan the location for the chiller and prepare the area properly.

Position the chiller as close to the process machine as possible. Place the chiller in position near the process machine so that coolant lines can be connected from the process machine to the chiller and back.

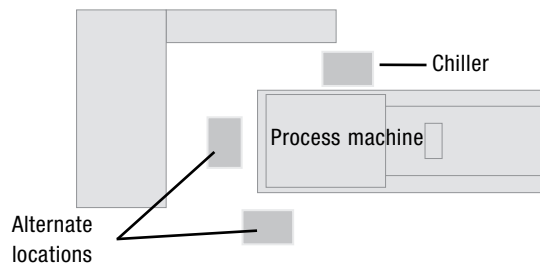

## Make sure the area where the chiller is installed has:

### A grounded power source.

Check the chiller's serial tag for the correct amps, voltage, phase and cycle. All wiring should be completed by a qualified technician and comply with your region's electrical codes.

### Clearance for safe operation and maintenance.

Ensure there is 2 ft {0.6 m} of clearance at the air intake and 2 ft {0.6 m} of clearance at the exhaust discharge for proper operation. Air flow is generated by the motor driven fan. Air flow is from the outside of the chiller, through the condenser and exhausted through the unit. Exhaust air can not be ducted on motor driven fan models.

Position the locking casters to prevent the chiller from moving. For maintenance and servicing, be sure there is enough clearance to remove all access panels completely.

### Available water source.

Ensure water make-up source is plumbed to the chiller's installation location. High points in the plumbing require vent valves; low points require drain valves.

 **NOTE:** Models must be positioned so that the condenser air inlet is no warmer than 95°F {35°C} and the condenser air outlet is not blocked or restricted in any way.

 **NOTE:** Locate models away from heat producing equipment. These items will affect ambient air conditions and the performance of the chiller.

## Making Process Plumbing Connections

All process piping materials (such as hoses, rigid piping, valves or filters) used with process water piping circuitry must be rated for 100°F {37.8°C} minimum temperature and 150 PSI {10.3 bar} minimum pressure.

All such materials must have the equivalent or larger diameter of the particular process connection that the length of process water piping is connected to.

Process water piping circuitry should be designed to avoid an excessive use of elbows and/or lengths of pipe or hose. If hose is the material of choice, avoid tight twists or curls and excessive lengths.

Valves and filters may be installed in the process water piping circuitry to facilitate service and maintenance provided that these devices maintain the full inside diameter of the process connection. If installed, all devices must be open and clean during unit operation.

Warm coolant from process equipment enters the chiller at the **“From Process”** inlet and chilled coolant returns to the process equipment through the **“To Process”** outlet.

To connect process plumbing:

- 1 Remove the shipping plastic pipe plugs from the female “To Process” and “From Process” connections on the back of the portable chiller.**
- 2 Make sure the male pipe threads are clean and new.**
- 3 Wrap the male pipe threads with Teflon tape or pipe dope.**
- 4 Connect the “From Process” valve (factory optional) on the back of the chiller to the “From Process” tubing that is from the “Water Out” manifold on the mold or process.** Start by hand until the threads engage and then tighten with an appropriately-sized pipe wrench. Tighten only enough to prevent leaks; do not over-tighten.
- 5 Connect the “To Process” valve (factory optional) on the back of the chiller to “To Process” tubing that is from the “Water In” manifold on the mold or process.** Start by hand until the threads engage and then tighten with an appropriately-sized pipe wrench. Tighten only enough to prevent leaks; do not over-tighten. If process lines are higher than the chiller, *see Appendix G, entitled Overhead Plumbing Details.*

 **NOTE:** The ability of the unit to maintain process temperature control depends on the method of installation.

 **NOTE:** Assure the piping installation has continuous flow at all times. If using a mechanical valve to regulate process flow you **MUST** install a bypass in the process piping.”

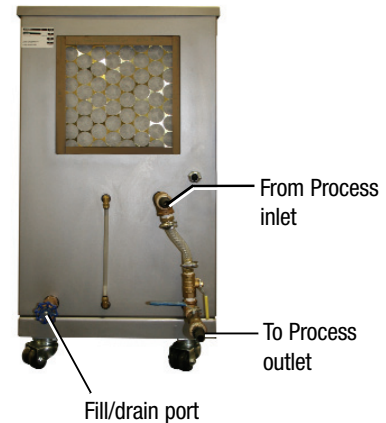

## Filling the Chiller

The chiller is shipped without coolant. The chiller is manually filled during installation using water as its coolant.

For atypical process temperatures below 45°F {7.2°C}, use the table below to determine the percentage (by volume) of glycol needed for the process temperature that is required. Mix the proper percentage of glycol with water.

**IMPORTANT:** The chiller's control does **not** monitor the percentage mixture of glycol.

Recommended Percentages of Glycol for Chilled Water Freeze Protection (by volume)		
Discharge water Temperature	% Propylene Glycol	% Water
40°F	20	80
30°F	30	70
25°F	40	60

**IMPORTANT:** Evaporator freeze-ups are **not** covered under warranty.

To fill with water:

- 1 Attach the water supply to the Fill/Drain valve,** located on the back of the chiller.
- 2 Open the “To Process” and “From Process” valves (factory optional).**
- 3 Open the Fill/Drain valve or water supply and fill the chiller to the 7/8 full level on the water level gauge.** If the chiller is overfilled, the excess water spills out the vent tube. **DO NOT OVERFILL.**
- 4 Close the Fill/Drain valve.**
- 5 Check the coolant level.** When the chiller is turned on the coolant level drops as it begins to circulate, filling the connected plumbing. Check the coolant level on the back of the chiller. Make sure the coolant level is filled to the 7/8 full level on the water level gauge. Shut down the chiller and add more coolant, if needed.
- 6 Disconnect water hose from Fill/Drain valve,** if the chiller is to be used elsewhere.

# Drain Connection

To drain the chiller for storage or transport:

- 1 Rotate the chiller's drain valve counterclockwise.** If using chemicals or additives with your process coolant, observe local disposal laws and regulations.

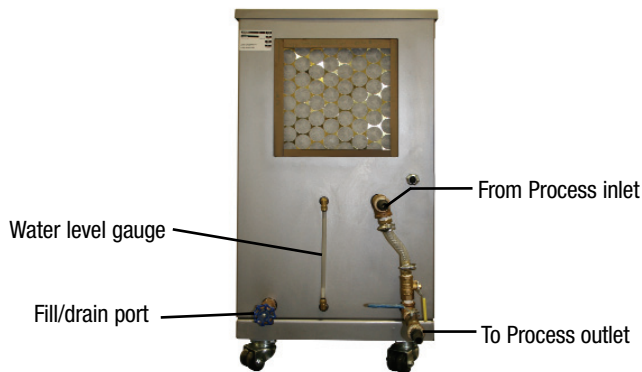

- 2 Close the chiller's drain valve** by turning it clockwise once final evacuation of all process coolant is complete.

**IMPORTANT:** Drainage procedures must be done prior to shipment or outdoor storage of the unit. If not, freezing damage can occur.

**IMPORTANT:** Ensure long-term storage environments are above freezing temperatures. If not, allow the chiller to thaw for several hours before returning it to operation or fill the chiller's internal piping with a high mixture of glycol to water during storage.

# Checking the Refrigerant Charge

 **WARNING: Refrigerant hazard**

Only certified refrigerant technicians should examine and correct problems involving the refrigerant circuit.

 **CAUTION:** Always disconnect and lock out the main power sources before making electrical connections. Electrical connections should be made only by a qualified electrical technician.

All chillers are fully charged with R-134A refrigerant from Conair. Your chiller's model nameplate identifies the type and amount of total refrigerant charge required.

Check the refrigerant charge while the chiller is running through the sight glass. Locate the sight glass by removing the left-side panel and using a flashlight, if necessary to check the sight glass:

- Under full load conditions**, the refrigerant should be clear (no bubbles).
- Under low load conditions**, when the Hot-gas Bypass valve is energized, bubbles may be visible in the sight glass. This is normal.

If the charge is low and the unit is under warranty, contact Conair service. Otherwise have a local, certified refrigeration technician add R-134A refrigerant to the system.

 **NOTE:** In this diagram, the chiller's panels are removed for clarity.

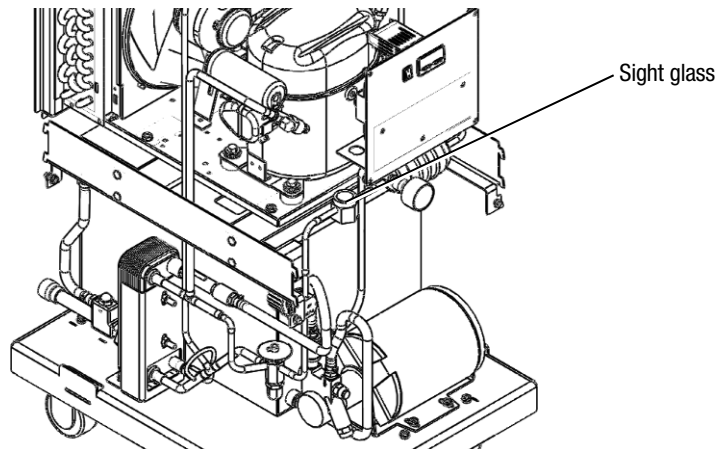

# Connecting the Main Power

The Conair EarthSmart ECM Chiller uses standard 115 Volt, 60 Hz or 220 Volt, 60Hz single-phase power, depending on model.

To connect the the main power to the chiller:

## 1 Connect the chiller's plug into a properly-sized and rated electrical outlet.

**IMPORTANT:** Depending on the state of the refrigeration system the compressor may turn on momentarily upon connecting power. The compressor will stop when the refrigerant is pumped into the condenser and a low pressure condition exists in the evaporator.

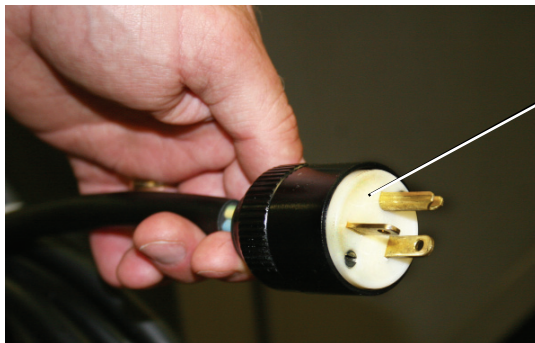

220 Volt/60 Hz,  
20 amp plug



**IMPORTANT:** Always refer to the wiring diagrams that came with your chiller to locate specific electrical components. Illustrations in the User Guide are intended to be representative only.



**CAUTION:** Always disconnect and lock out the main power sources before making electrical connections. Electrical connections should be made only by a qualified electrical technician.





# Operation

---

EarthSmart ECM Series Chiller:

Control descriptions . . . . . 4-2

Starting the chiller . . . . . 4-3

Stopping the chiller . . . . . 4-4

Changing temperature units . . . . . 4-5

Chiller operation sequence . . . . . 4-6

Resetting the high pressure switch  
of the compressor . . . . . 4-8

# EarthSmart ECM Chiller: Control Descriptions

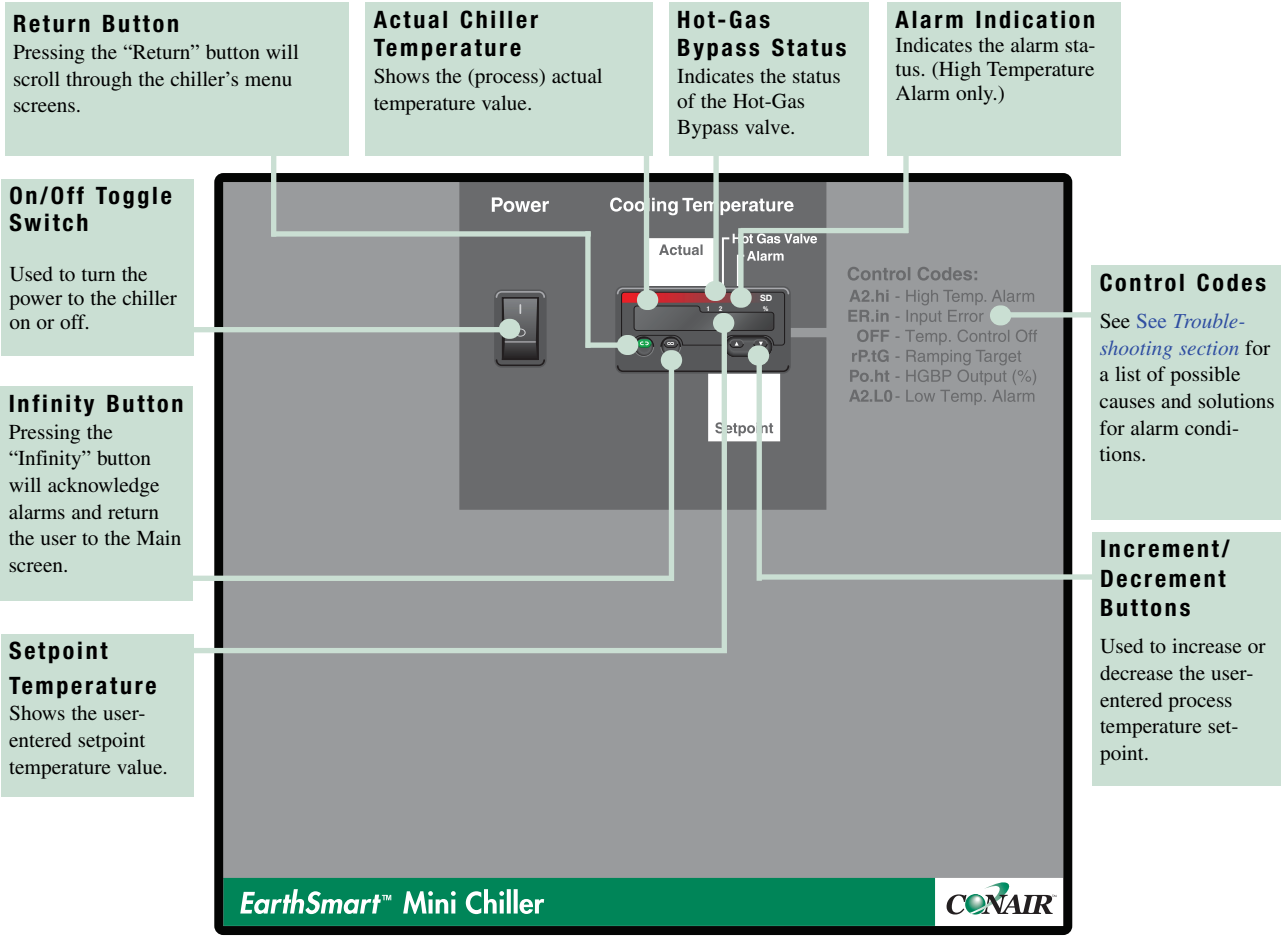

# Starting the Chiller

To start the chiller:

- 1 Toggle the power switch to the On or “I” position.** The control display will illuminate. Facing the chiller’s control, the “**To Process**” actual temperature will be on the left, the setpoint temperature is on the right. *See Operation section entitled, Chiller Sequence of Operation.*
- 2 Set the cooling temperature setpoint.** Use the up arrow button ▲ on the control, to raise the setpoint. Use the down arrow button ▼ to lower the setpoint. The temperature will ramp up at approximately 1 (one) degree per second. After 2 (two) seconds of inactivity the setpoint entered will become the targeted setpoint temperature.

## Infinity Button

Pressing the “Infinity” button will acknowledge alarms and return the user to the Main screen.



On Position

 **NOTE:** If the setpoint displays “OFF” in the display, raise the setpoint with the up arrow button ▲ to see the actual setpoint.

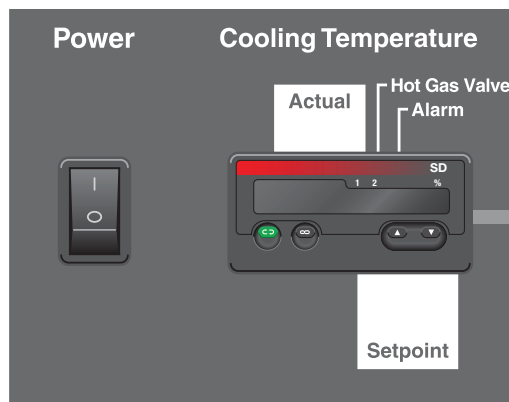

# Stopping the Chiller

To stop the chiller:

- 1 Toggle the power switch to the Off or “O” position.

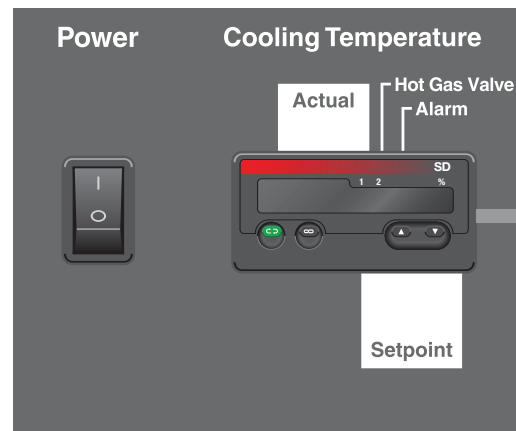

**IMPORTANT:** Do **NOT** rapidly cycle the chiller’s power on and off (short cycle). Once the power has been turned off, wait at least three (3) minutes before cycling the chiller’s power back on.

# Changing Temperature Unit

To stop the chiller:

- 1 Press the green “Return” button  once to access the Temperature Units Selection screen. Press the ▲ or ▼ buttons to toggle between fahrenheit and celsius temperature units.

 **NOTE:** The temperature display will not indicate Fahrenheit or Celsius temperature units. The chiller's control is set for Fahrenheit temperature units as standard from Conair.

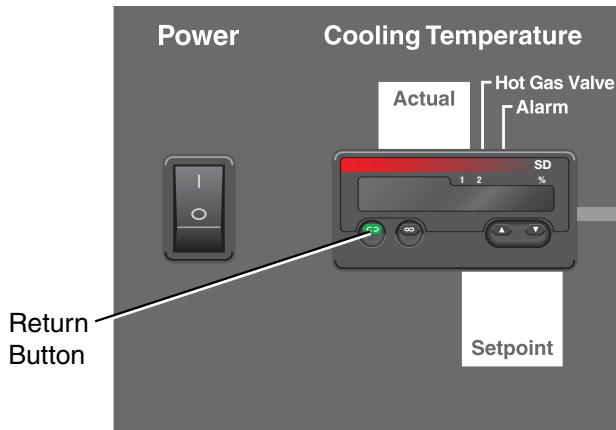

- 2 Press the “Infinity” button  to lock in the selection and return to the Main screen. The control will default back to the Main screen if no buttons are pressed after 1 minute.

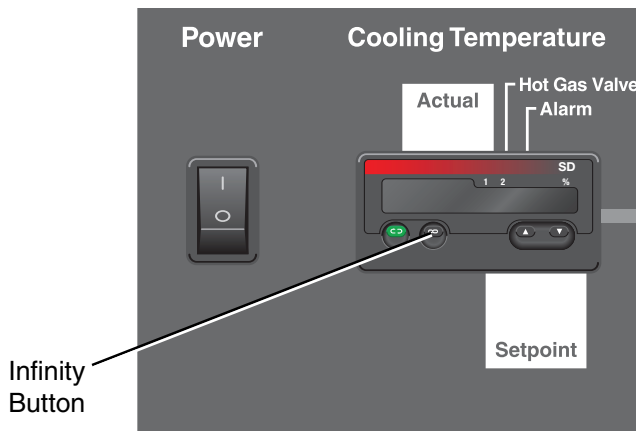

# Chiller Operation Sequence

The EarthSmart ECM Series Chiller has a unique user interface that controls the process temperature and prevents refrigeration migration during compressor off times.

**When the main power is connected:**

**1 Depending on the state of the refrigeration system, the compressor may turn on momentarily upon connecting power.** The compressor will stop when the refrigerant is pumped into the condenser and a low pressure condition exists in the evaporator.

**When the power toggle switch is turned to the “On” or “I” position:**

**2 Turning the toggle switch on immediately starts the process pump and illuminates the control.** When flow is established and the unit is not in a low temperature alarm, the Liquid Line Solenoid valve (LLSV) will open. This allows the refrigerant to migrate to the evaporator and increase the pressure. When the low refrigerant pressure switch is satisfied the compressor will turn on and process coolant will begin cooling.

**3 When the process temperature is above setpoint the compressor will run and the Hot-Gas Bypass valve (HGBP) will not open.** If the process temperature falls below the setpoint, the HGBP valve will energize, raising the actual process temperature to maintain the user-entered setpoint temperature. The HGBP valve can energize up to 9 out of 10 seconds. If there is less load on the chiller and the temperature continues to fall to 4°F {2.2°C} below the user-entered setpoint the controller will alarm (A2.lo) and close the LLSV. The compressor will pump the refrigerant out of the evaporator and the low pressure switch will shut off the compressor. This is a normal function of the chiller and will not require troubleshooting.

**4 The controller stays in this alarm condition (A2.lo) until the temperature is 2°F {1.1°C} above the user-entered setpoint,** at which point the controller allows the LLSV to re-open and the compressor to restart.

(continued)

## Chiller Operation Sequence (continued)

- 5** The condenser fan can energize anytime the toggle switch is in the “On” or “I” position. The fan is controlled by the fan cycling (high refrigeration) pressure switch. This switch maintains the high side refrigeration pressure under cooler ambient temperatures and lower loads. The fan will turn on when the high refrigeration pressure reaches 200 PSI {13.8 bar}. It will turn off when the pressure drops below 125 PSI {8.6 bar}.
- 6** The high refrigeration safety pressure switch shuts off the compressor immediately when the high refrigeration pressure reaches 230 PSI {15.9 bar} without going through pump down during a low pressure cycle. If the high pressure switch trips, it must be manually reset by pressing the “Reset” button on the switch. The compressor can start immediately when this is reset so caution should be exercised. *See Operation section entitled, Resetting the Compressor’s High Pressure Switch.*



**CAUTION:** The compressor can start immediately when the High Pressure “Reset” button is pressed.

## Resetting the High Pressure Switch of the Compressor



**CAUTION:** The compressor can start immediately when the High Pressure “Reset” button is pressed.

The high refrigeration safety pressure switch shuts off the compressor immediately when the high refrigeration pressure reaches 230 PSI {15.9 bar} without going through pump down during a low pressure cycle. If the high pressure switch trips, it must be manually reset by pressing the “Reset” button on the switch. The compressor can start immediately when this is reset so caution should be exercised.

To reset the high refrigeration safety switch:

- 1 Be sure the main power is disconnected** and the chiller is locked out. Always disconnect/unplug and/or lockout the main power source before opening the unit for servicing.
- 2 Remove the chiller’s right-side panel,** as viewed from the control.
- 3 Locate the high refrigeration safety switch** within the top portion of the chiller’s cabinet.



**NOTE:** The High Pressure Safety switch may not reset due to the chiller’s refrigerant state. Allow the refrigerant to cool before attempting to reset.

- 4 Push the “Reset” button,** until there is a “click”.
- 5 Replace the chiller’s right-side panel,** as viewed from the control.
- 6 Reapply main power.**



# Maintenance

---

Preventative maintenance schedule . . . . . 5-2

Checking electrical connections. . . . . 5-4

Cleaning the brazed plate adapter . . . . . 5-5

Cleaning the air-cooled condenser . . . . . 5-7

Checking the reservoir level . . . . . 5-9

Cleaning the pump strainer . . . . . 5-10

Checking the refrigerant charge  
and quality . . . . . 5-12

# Preventative Maintenance Schedule

## Daily, or as often as needed

- Checking process fluid level in the pump tank**  
Check the process fluid level in the water level gauge on the back of the chiller. If low, *see Maintenance section entitled, Checking the Reservoir Level.*
- Verifying pump discharge pressure**  
While the pump is running, check to ensure that the pump pressure gauge (located on the front of the chiller) is within range. To change the pressure, open or close the “**To Process**” valve (factory optional).
- Inspecting piping for leaks**  
Check to see that pipes are not leaking. Look for standing water on the floor or inside the chiller cabinet.
- Inspecting the condenser coil for debris**  
Check the condenser for adequate air flow. Check the condenser face for dirt and clogging. If dirt or clogs are present, clean the condenser, *see Maintenance section entitled, Cleaning the Air-cooled Condenser.* Check, clean, and/or replace the filter at the air inlet of the air-cooled condenser coil, as needed.

## Weekly, or as often as needed

- Checking temperature and pressure readings**  
Check that the temperature displays on the control screen and the reading on the pressure gauge (located on the front of the chiller) indicates normal operation. *See Description section entitled, Pump Curve: EarthSmart ECM Series Chillers.*
- Inspecting the filter**  
Check, clean and/or replace the filter at the air inlet of the air-cooled condenser coil, as needed. *see Maintenance section entitled, Cleaning the Air-cooled Condenser.*
- Checking refrigerant site glass**  
There should not be any bubbles. *See Maintenance section entitled, Checking the Refrigerant Charge and Quality.*
- Checking reservoir level**  
Check the water level gauge on the back of the chiller. If fluid level is low, fill, *see Maintenance section entitled, Checking Reservoir Level.*

# Preventative Maintenance Schedule

(continued)

## Monthly

- Inspecting cooling water treatment system**  
If your chiller uses a cooling water treatment system, maintain proper chemical levels and follow the recommendations of your water treatment specialist. Change water in the reservoir tank monthly to reduce water hardness.
- Checking electrical connections, amps and volts**  
Check to ensure the electrical connections are properly seated and that the chiller is operating at its rated amps and voltage. *See Description section entitled, Specifications: EarthSmart ECM Series Chillers.*
- Cleaning**  
Wipe all external surfaces to maintain performance.
- Inspecting condenser**  
Check the air-cooled condenser for adequate air flow. Check the condenser face for dirt and clogging. If dirt or clogs are present, clean the condenser. Check, clean and/or replace the filter at the air inlet of the air-cooled condenser coil, as needed. *See Maintenance section entitled, Cleaning the Air-cooled Condenser.*
- Inspecting the control panel**  
Check for loose wires, burned contacts and signs of overheated wires. Check that all panel lights illuminate. *See Maintenance section entitled, Checking Electrical Connections.*
- Checking refrigerant charge and quality**  
With the compressor running, check the sight glass between the receiver and evaporator for proper refrigerant condition. *See Maintenance section entitled, Checking Refrigerant Charge and Quality.*
- Checking the pump strainer.**  
Check to ensure the pump strainer is not clogged or damaged, replace as needed. *See Maintenance section entitled, Cleaning the Pump Strainer.*

## Annually

- Cleaning the evaporator**  
*See Maintenance section entitled, Cleaning the Brazed Plate Evaporator.*
- Check refrigerant piping**  
Verify that no oil is present on fittings or cabinet. Wipe clean and check charge/operation of circuit.

# Checking Electrical Connections



## **WARNING: Electrical Hazard**

Before performing any work on this item, disconnect and lock out electrical power sources to prevent injury from unexpected energization or startup. Be sure that power to the chiller is OFF when doing any maintenance on the chiller. Follow all safety rules when performing any maintenance on this equipment.



## **WARNING: Improper installation, operation or servicing may result in equipment damage or personal injury.**



**NOTE:** Always refer to the wiring diagrams you received with your chiller to locate specific electrical components.

This equipment should only be installed, adjusted and serviced by a qualified technician who is familiar with the construction, operation and potential hazards of this type of machine.

All wiring, disconnects and fuses should be installed by a qualified electrical technician in accordance with electrical codes in your region.

To check electrical connections:

- 1 Be sure the main power is disconnected** and/or the chiller is locked out. Always disconnect/unplug and lockout the main power source before opening the unit for servicing.
- 2 Remove the chiller's top lid**, by first removing both side panels and then the four (4) retaining bolts that secure the chiller's top lid.
- 3 Inspect all wires and connections.**  
Look for loose wires, burned contacts and signs of over-heated wires. Compare the wiring to the wiring diagrams you received with your chiller. Have a qualified electrician make any necessary repairs or replacements.
- 4 Replace the chiller's side panels and then the top lid** by replacing the four (4) retaining bolts.
- 5 Inspect the exterior power cords.**  
Cords should not be crimped, exposed or rubbing against the frame. If the main power cord runs along the floor, make sure it is positioned where it could not rest in pooling water or could not be ran over and cut by wheels or casters.



**NOTE:** Also inspect the chiller's plug wiring terminations.

# Cleaning the Brazed Plate Evaporator

Minerals and other contaminants produce deposits, scales, slime or algae on the heat transfer surfaces exposed to water. Fouled surfaces could result in decreased cooling capacity. Implement a water treatment program to slow the fouling.

 **CAUTION: Hot Surfaces**

Always protect yourself from hot surfaces when working on the chiller, especially when working on or around the compressor and condenser. These devices can reach over 160°F {71°C}. Allow these devices to cool before performing any maintenance or troubleshooting.

Water quality should be maintained at a pH level of 7.4, but not less than 6.0 for proper heat exchanger life.

To clean the brazed plate adapter:

- 1 Prepare a 5% solution of Phosphoric acid or Oxalic acid and water.** Do not heat the acid solution.
- 2 Disconnect and/or lockout main power to the chiller.**
- 3 Shut the “To” and “From Process” valves (factory optional) and the drain reservoir.** See *Installation section entitled, Drain Connection.*
- 4 Remove the chiller’s side panels.**
- 5 Disconnect the pump from the heat exchanger.** Install a cap in the opening of the heat exchanger where the pump was connected.

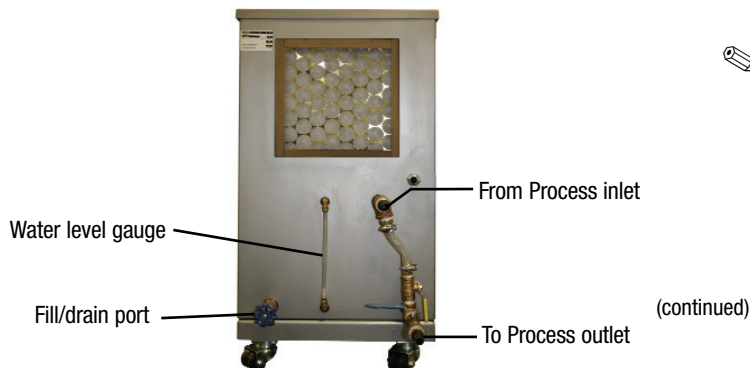

 **NOTE:** These connections may vary depending on the model you have purchased. Be sure to see the labeling on your particular unit.

# Cleaning the Brazed Plate Evaporator

(continued)



## CAUTION: Hot Surfaces

Always protect yourself from hot surfaces when working on the chiller, especially when working on or around the compressor and condenser. These devices can reach over 160°F {71°C}. Allow these devices to cool before performing any maintenance or troubleshooting.

- 5 Remove RTD from bottom of evaporator.**
- 6 Connect 3/8-inch tubing to the 3/8-inch connections of the heat exchanger.**  
SEE below to install customer-supplied chemical pump and solution fitted to the heat exchanger.
- 7 Back-flush the solution through the heat exchanger and the chiller.**
- 8 Flush the heat exchanger and the chiller piping with fresh water after cleaning.**
- 9 Reconnect the chiller pump to the heat exchanger.** Remove the cap in the heat exchanger and reconnect the hose to the pump.



**NOTE:** These connections may vary depending on the model you have purchased. Be sure to see the labeling on your particular unit.

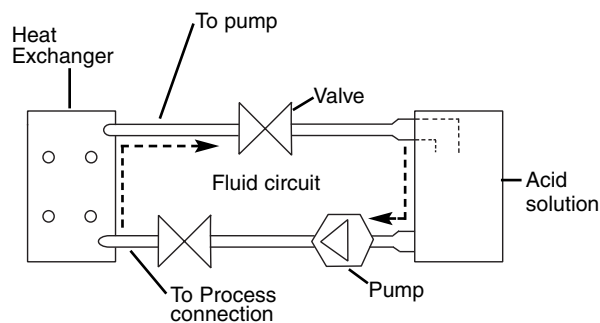

# Cleaning the Air-Cooled Condenser



## **WARNING: Electrical Hazard**

Before performing any work on this item, disconnect and lock out electrical power sources to prevent injury from unexpected energization or startup. Be sure that power to the chiller is OFF when doing any maintenance on the chiller. Follow all safety rules when performing any maintenance on this equipment.



## **CAUTION: Hot Surfaces**

Always protect yourself from hot surfaces when working on the chiller, especially when working on or around the compressor and condenser. These devices can reach over 160°F {71°C}. Allow these devices to cool before performing any maintenance or troubleshooting.

The air-cooled condenser and condenser filter can accumulate dirt and clog quickly if it is ran in a dusty or dirty environment. A clogged condenser or condenser filter increases refrigerant discharge pressure, lowers performance, and may cause the fan motors and compressor to overheat.

To clean the air-cooled condenser:

- 1 Disconnect and/or lockout main power to the chiller.**
- 2 Remove the chiller's top lid**, by first removing both side panels and then the four (4) retaining bolts that secure the chiller's top lid.
- 3 Remove the filter**, that is located towards the back of the chiller, by lifting it straight up and out of the chiller.
- 4 Inspect the condenser coils.** Use a flashlight to check between coil surfaces.
- 5 Clean the dirty coils with a soft brush.**
- 6 Flush with cool water or a commercial coil cleaner that is compatible with aluminum alloys.** It is recommended that the coil cleaner is sprayed from inside the cabinet.

(continued)

## Cleaning the Air-Cooled Condenser (continued)

**Replacement air filters are available from Conair.**

Contact Conair Parts  
(800) 458 1960  
From outside of the  
United States, call:  
(814) 437 6861

- 7 Check the air filter.** If the filter is blinded or torn, replace the filter.
- 8 Replace the chiller's side panels and then the top lid** by replacing the four (4) retaining bolts.
- 9 Reapply main power.**



### **CAUTION: Wear eye protection.**

If you use compressed air to clean the equipment, you must wear eye protection and observe all OSHA and other safety regulations pertaining to the use of compressed air.



# Checking Reservoir Level



## **WARNING: Electrical Hazard**

Before performing any work on the chiller, disconnect and lock out electrical power sources to prevent injury from unexpected energization or startup. Be sure that power to the chiller is OFF when doing any maintenance on the chiller. Follow all safety rules when performing any maintenance on this equipment.

Check the coolant level in the reservoir. The coolant level in the sight glass on the back of the chiller should be 7/8 full.

To manually fill the reservoir:

- 1 Disconnect and lockout power to the chiller.**
- 2 Locate the Fill/Drain valve on the back of the chiller.** Open the Fill/Drain valve or coolant supply and fill the chiller to the 7/8 full level on the water level gauge. If the chiller is overfilled, the excess water spills out the vent tube. **DO NOT OVERFILL.**
- 3 Refill the reservoir.** Monitor the level using the water level indicator on the back of the chiller, ensuring you are adding the correct fluid for your application.
- 4 Close the Fill/Drain valve.**
- 5 Check the coolant level.** When the chiller is turned on the coolant level drops as it begins to circulate, filling the connected plumbing. Check the coolant level on the back of the chiller. Make sure the coolant level is filled to the 7/8 full level on the water level gauge. Shut down the chiller and add more coolant, if needed.
- 6 Disconnect water hose from Fill/Drain valve,** if the chiller is to be used elsewhere.

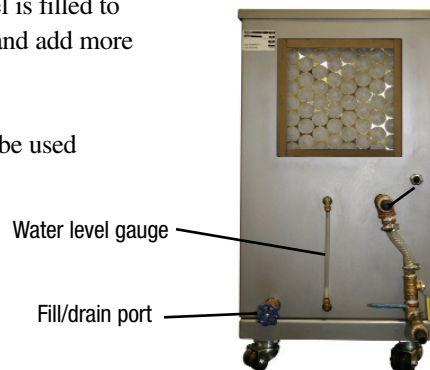

# Cleaning the Pump Strainer

EarthSmart Chillers use a rotary pump to flow process coolant through their internal piping and to the process. A strainer on the pump may periodically need cleaning, depending upon the quality of the process coolant.



## **WARNING: Electrical Hazard**

Before performing any work on the chiller, disconnect and lock out electrical power sources to prevent injury from unexpected energization or startup. Be sure that power to the chiller is OFF when doing any maintenance on the chiller. Follow all safety rules when performing any maintenance on this equipment.

To clean the pump's strainer:

- 1 Be sure the main power is disconnected** and/or the chiller is locked out. Always disconnect/unplug and lockout the main power source before opening the unit for servicing.
- 2 Drain all process coolant from the chiller,** *see Installation section entitled, Drain Connection.*
- 3 Remove the chiller's right-side panel.** (As viewed from the control)
- 4 Locate the chiller's pump.** It is located in the lower portion of the chiller' cabinet and towards the front of the chiller.

Strainer end cap

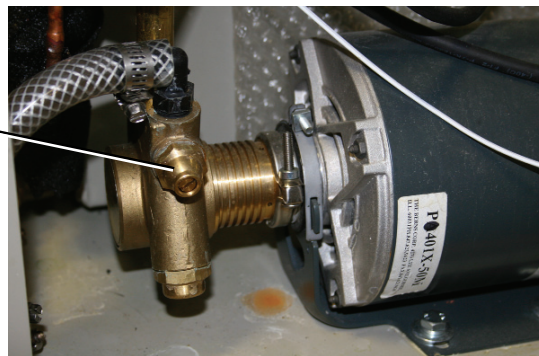

**NOTE:** The front panel of the chiller has been removed in this image for clarity.

- 5 Locate the pump strainer's end cap,** remove the cap by unscrewing it counter-clockwise with an appropriately-sized wrench.

(continued)

## Cleaning the Pump Strainer (continued)

- 6** Remove the strainer from its housing.
  - 7** Inspect the strainer for holes or blinding, clean or replace as necessary.
  - 8** Re-install the strainer and strainer cap. Properly seal all piping with approved Teflon tape or pipe dope.
- IMPORTANT:** Check to ensure the strainer is properly seated before applying the strainer cap. Crushing of the strainer can occur if it is not fully inserted back into the strainer housing.
- 9** Check to ensure no leaking has occurred before returning the chiller to normal operation.

Replacement strainers are available from Conair.

Contact Conair Parts  
(800) 458 1960  
From outside of the  
United States, call:  
(814) 437 6861

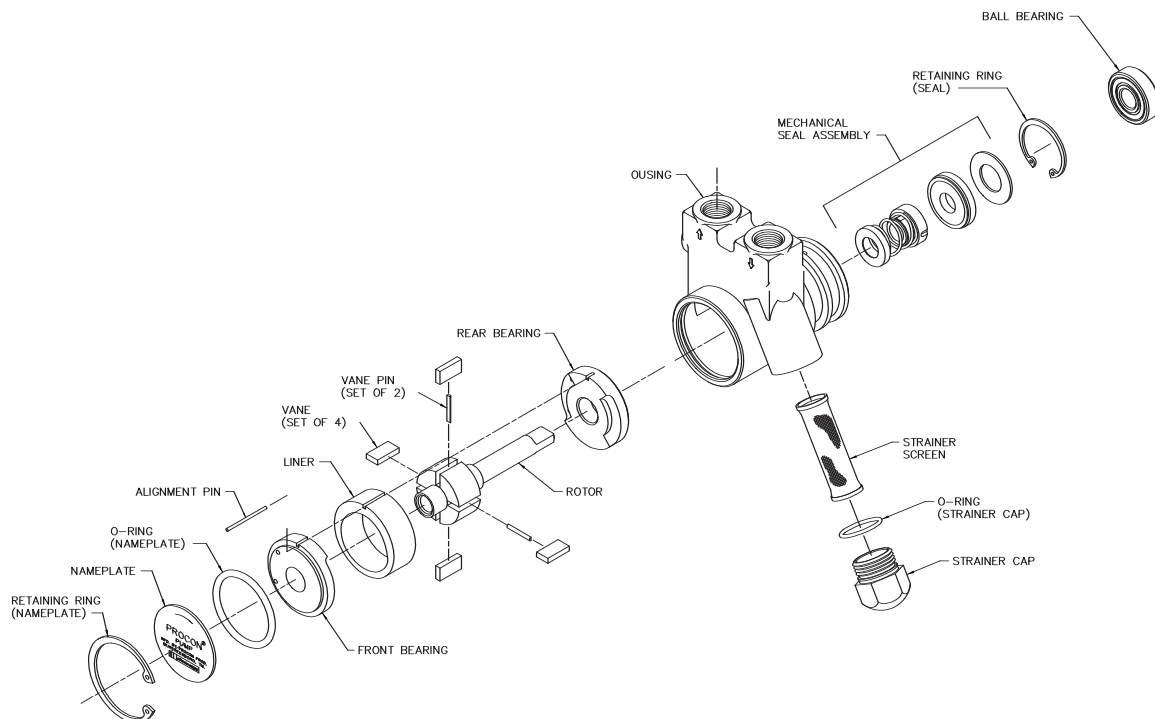

# Checking the Refrigerant Charge and Quality

## **WARNING: Refrigerant Hazard**

Only certified refrigerant technicians should examine and correct problems involving the refrigerant circuit.

 **CAUTION:** Always disconnect and lock out the main power sources before making electrical connections. Electrical connections should be made only by a qualified electrical technician.

All chillers are fully charged with R-134A refrigerant from Conair. Your chiller's model nameplate identifies the type and amount of total refrigerant charge required. *See Description section entitled, Specifications: EarthSmart ECM Series Chillers.*

Check refrigerant charge while the chiller is running under normal load. Check the refrigerant charge through the sight glass. Use a flashlight, if necessary, and check the liquid-line sight glass:

- **Under full load conditions**, the refrigerant should be clear (no bubbles).
- **Under low load conditions**, when the Hot-Gas Bypass valve (HGBP) is operating, bubbles may be visible in the sight glass. This is normal.

A refrigerant quality label is located within the sight glass. A green label is normal. A yellow or dark brown label indicates that the refrigerant is contaminated and must be replaced.

 **NOTE:** In this diagram, the chiller's panels are removed for clarity.

If the charge is low or contaminated and the chiller is under warranty, contact Conair service; or have a local, certified refrigeration technician service the system.

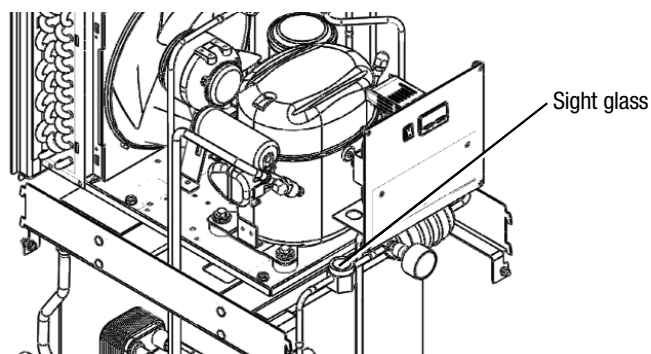

# Troubleshooting

---

Before beginning . . . . . 6-2

A few words of caution . . . . . 6-3

DIAGNOSTICS

How to identify the cause of a problem . . . . 6-3

Alarms . . . . . 6-4

Troubleshooting . . . . . 6-5

Checking or replacing the

    temperature sensor . . . . . 6-8

Checking or resetting the circuit breakers . . . 6-9

## Before Beginning

You can avoid most problems by following the recommended installation and maintenance procedures outlined in this User Guide. If you do have a problem, this section will help you determine what caused it and how to fix it.

### ❑ Diagnose causes from the control panel.

- 1 Note the alarm and press the “Infinity”  button once to acknowledge the alarm** and resume control if required.
- 2 Address the alarm message and fix the problem.** *See [Troubleshooting section](#) for descriptions of possible alarm conditions.*
- 3 If the alarm reappears the problem was not fixed.**

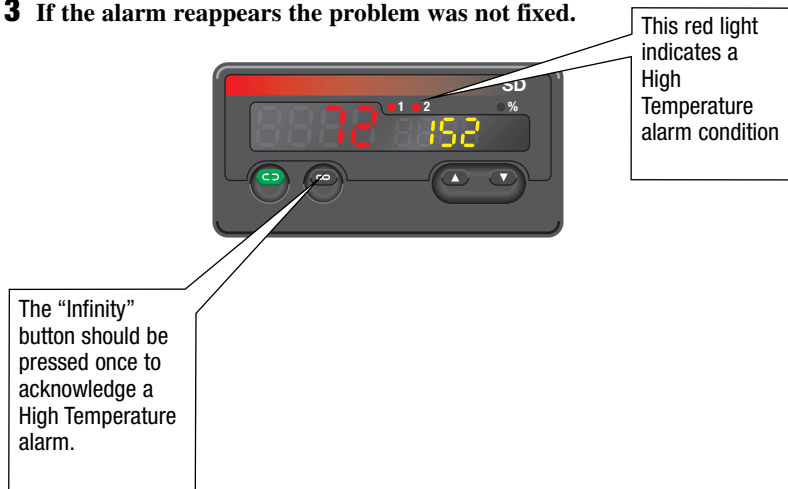

- ### ❑ Find the wiring and equipment diagrams that were shipped with your chiller.
- These diagrams are the best reference for correcting a problem. The diagrams also will note any custom features, such as special wiring or alarm capabilities, not covered in this User Guide.

## A Few Words of Caution

Improper corrective actions can lead to hazardous conditions and should never be attempted to sustain production.



**WARNING: Only a qualified electrical technician should examine and correct problems that require opening the chiller's electrical enclosure or using electrical wires to diagnose the cause.**



**WARNING: High voltage. Always stop the chiller, disconnect and lock out the main power source before troubleshooting or performing repairs.**



**CAUTION: Hot surfaces. Always protect yourself from hot surfaces inside and outside of the chiller.**

## How to Identify the Cause of a Problem

The High Temperature Alarm is indicated by an illuminated alarm light on the EarthSmart ECM control panel and an alarm code, (A2.hi) is displayed in the control display.

When an alarm code is displayed in the control:

- 1 Find the error message in the diagnostics table** of this *Troubleshooting section* and reference the control labeling in the upper right-hand side of the control face.
- 2 Note that, after correcting the problem, pressing the “Infinity” button**  will clear the alarm. The alarm will only clear if the condition causing the alarm has been corrected.

# Alarms

If the red alarm LED is illuminated, an alarm is activated. The chiller has automatically pumped down because it has detected a serious problem that could damage your process or chiller. Note that the alarm must be acknowledged before the control will resume operation by pressing the “Infinity” button. 

Problem	Possible cause	Solution
<p><b>A2.hi (Alarm light illuminated)</b> – If the “To Process” temperature exceeds the process high temperature deviation setpoint, it shuts down the chiller. Default is set to 20°F {11.1°C}.</p>	<p>The Hot-gas Bypass valve is not operating properly (stuck open).</p> <p>Load is too high for the chiller.</p> <p>Process coolant is not flowing between the supply outlet and return inlet.</p> <p>Dirty condenser coil.</p> <p>Ambient temperature is above 95°F {35°C}.</p> <p>Warm process coolant.</p>	<p>Have a certified refrigeration technician replace the solenoid valve.</p> <p>Remove some load from the process.</p> <p>Check for plugged pipes, closed valves, or failed flow switch(es).</p> <p>Clean condenser coil. <i>See Maintenance section entitled, Cleaning the Air-cooled Condenser.</i></p> <p>Lower ambient temperature or move the chiller to a lower temperature environment.</p> <p>Lower the temperature of the process coolant.</p>
<p><b>Er.in (Input error)</b></p>	<p>Failed RTD.</p> <p>Loose RTD connection to the control.</p> <p>Reversed RTD input.</p>	<p>Replace the RTD. <i>See Troubleshooting section entitled, Checking or Replacing the Temperature Sensor and Appendix F entitled, RTD Resistance Chart.</i></p> <p>Check RTD connection to the controller. Resecure as necessary.</p> <p>Check RTD wiring.</p>
<p><b>A2.lo – (Alarm light illuminated)</b> – If the “To Process” temperature exceeds the process low temperature deviation setpoint, it closes the liquid line solenoid valve and the compressor pumps down and shuts down. Default is set to 4°F {2.2°C}.</p>	<p>Load is too low for the chiller.</p>	<p>The chiller’s compressor will automatically restart once the “To Process” temperature exceeds the user-entered setpoint on the control by 2°F {1.1°C}.</p>



# Troubleshooting

Problem	Possible cause	Solution
<p><b>The chiller will not start. (Control not illuminated)</b></p>	<p>Tripped circuit breaker.</p>	<p>Verify resistance to ground. Reset breaker. <i>See Troubleshooting section entitled, Checking or Resetting the Circuit Breakers.</i></p>
	<p>Incorrect incoming voltage.</p>	<p>Check incoming power source for correct voltage and amperage as detailed on the chiller nameplate. <i>See Description section entitled, Specifications: EarthSmart ECM Series Chillers.</i></p>
<p><b>Pump will not start.</b></p>	<p>The power toggle switch is not turned to the “On” or “I” position.</p>	<p>Turn the power toggle switch on the control to the “On” or “I” position.</p>
	<p>Open motor winding.</p>	<p>Contact Conair Service.</p>
	<p>Internal overload has tripped.</p>	<p>Auto-resetting. Allow the chiller’s motor to cool and restart the chiller.</p>
	<p>Loose wire connection or defective start capacitor.</p>	<p>Check wiring diagrams, <i>see Appendix H entitled, Electrical Schematic</i>, replace connections or capacitor.</p>
	<p>CB2 circuit breaker has been tripped.</p>	<p>Verify resistance to ground. Reset breaker. <i>See Troubleshooting section entitled, Checking or Resetting the Circuit Breakers.</i></p>

## Troubleshooting (continued)

Problem	Possible cause	Solution
<p><b>Compressor will not start.</b></p>	<p>High pressure switch has been tripped.</p>	<p>Reset the High Pressure switch. <i>See Operation section entitled, Resetting the High Pressure Switch.</i></p>
<p> <b>NOTE:</b> Also, see <i>Troubleshooting section, entitled, Troubleshooting, “Chiller shuts down due to a High Pressure switch alarm” and “Chiller shuts down due to a Low Pressure switch”.</i></p>	<p>Circuit breaker has been tripped.</p>	<p>Verify resistance to ground. Reset breaker. <i>See Troubleshooting section entitled, Checking or Resetting the Circuit Breakers.</i></p>
	<p>Loose wire connection or defective start capacitor.</p>	<p>Check wiring diagrams, <i>see Appendix H entitled, Electrical Schematic</i>, replace connections or capacitor.</p>
	<p>The actual “To Process” temperature is below the setpoint.</p>	<p>Lower setpoint temperature value. <i>See Operation section entitled, Starting the Chiller.</i></p>
	<p>Damaged or defective start capacitor.</p>	<p>Contact Conair Service.</p>
	<p>Poor water flow.</p>	<p>Check pump rotation.</p> <p>Clean the pump strainer. <i>See Maintenance section entitled, Cleaning the Pump Strainer.</i></p>
	<p>Damaged or defective compressor.</p>	<p>Have a certified refrigeration technician replace the compressor.</p>

## Troubleshooting (continued)

Problem	Possible cause	Solution
<p><b>Chiller shuts down due to a High Pressure switch alarm.</b></p>	<p>Low air flow across the condenser.</p> <p>Fan not operating.</p> <p>High ambient temperature.</p> <p>Insufficient clear space around unit.</p> <p>Clogged air filter.</p>	<p>Check for dirty condenser fins. Clean as necessary. <i>See Maintenance section entitled, Cleaning the Air-cooled Condenser.</i></p> <p>Reset High Pressure switch. <i>See Operation section entitled, Resetting the High Pressure Safety Switch.</i></p> <p>Check for loose fan blade or open/grounded motor winding.</p> <p>Move the chiller to a lower ambient temperature location.</p> <p>Increase clearance around the chiller.</p> <p>Replace filter. <i>See Maintenance section entitled, Cleaning the Air-cooled Condenser.</i></p>
<p><b>Chiller shuts down due to a Low Pressure switch.</b></p> <p> <b>NOTE:</b> This is a normal shutdown for other alarm conditions when the chiller's main power has been switched off.</p>	<p>Attempting to operate the chiller with process coolant below 45°F {7.2°C}.</p> <p>Low refrigerant charge.</p> <p>Poor heat transfer in the evaporator tank due to a high percentage of glycol to water.</p> <p>Low flow through the evaporator due to glycol foaming.</p> <p>Low flow through the evaporator.</p> <p>Faulty pump motor.</p> <p>Clogged pump strainer.</p>	<p>Increase temperature setpoint above 45°F {7.2°C}. <i>See Operation section entitled, Starting the Chiller.</i></p> <p><i>See Installation section entitled, Checking the Refrigerant Charge.</i></p> <p>Reduce the glycol mixture of the process coolant. <i>See Installation section entitled, Filling the Chiller.</i></p> <p>Replace the process coolant. <i>See Installation section entitled, Filling the Chiller.</i></p> <p><i>See Maintenance section entitled, Cleaning the Brazed Plate Evaporator.</i></p> <p>Contact Conair Service.</p> <p>Clean or replace the strainer. <i>See Maintenance section entitled, Cleaning the Pump Strainer.</i></p>

## Checking or Replacing the Temperature Sensor



**IMPORTANT:** Always refer to the wiring diagrams that came with your chiller to locate specific electrical components. Illustrations in the User Guide are intended to be representative only.

The EarthSmart ECM Series Chiller uses a RTD sensor to monitor the temperature of the process coolant.

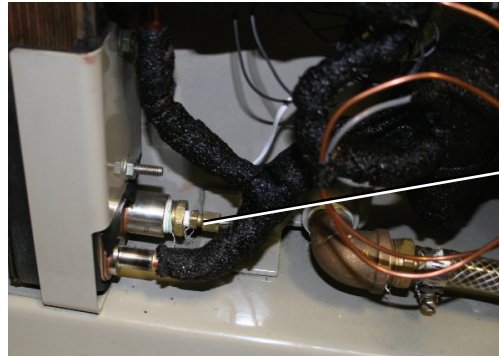

Typical location of the RTD at the chiller's evaporator.

To check or replace an RTD sensor:

- 1 Disconnect and/or lockout the main power supply.**
- 2 Locate the RTD sensor.**
- 3 Check the sensor's position and condition.** Temperature readings will be incorrect if the sensor is touching the wall of a pipe or if the sensor or wiring is damaged. Sensor wires should be attached to the appropriate connection points on the chiller's control center.
- 4 To check with ohm meter,** measure the resistance across the RTDs. The resistance should be approximately 110 ohm at room temperature. *See Appendix F entitled, RTD Resistance Chart.*
- 5 Remove the sensor from its housing using an appropriately-sized wrench.**
- 6 Inspect the sensor for cleanliness.** Replace if necessary with another sensor of the same rating.
- 7 Replace the RTD, by wrapping the its threads with Teflon tape or pipe dope.**
- 8 Re-insert the RTD into its housing,** start by hand until its threads engage. Tighten with an appropriately-sized wrench, do not over tighten.

**Replacement RTDs are available from Conair.**

Contact Conair Parts  
(800) 458 1960  
From outside of the  
United States, call:  
(814) 437 6861

# Checking or Resetting the Circuit Breakers

The EarthSmart ECM Series Chiller uses electrical circuit breaker to protect the chiller from overloads or improper operating conditions.

 **IMPORTANT:** Always refer to the wiring diagrams that came with your chiller to locate specific electrical components. Illustrations in the User Guide are intended to be representative only.

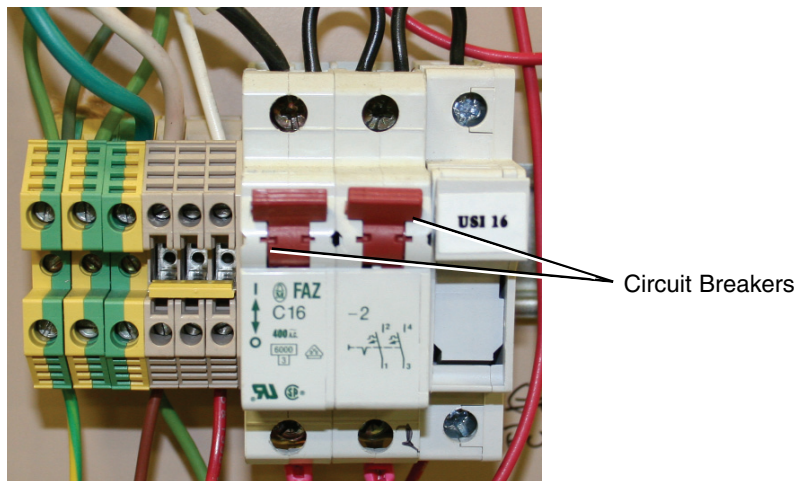

To check or reset the chiller's circuit breakers:

- 1 Disconnect and lockout the main power supply.** 
- 2 Remove the chiller's top lid,** by first removing both side panels and then the four (4) retaining bolts that secure the chiller's top lid.
- 3 Locate the appropriate circuit breaker(s), located behind the chiller's control panel.** See the wiring diagrams that came with your chiller.
- 4 Check the circuit breaker(s) position and condition.** The chiller will not operate correctly if one or more circuit breakers have been tripped (facing down).
- 5 Reset the circuit breaker(s),** if necessary.
- 6 Replace the chiller's side panels and then the top lid** by replacing the four (4) retaining bolts.
- 7 Reapply main power.**

Additional manuals and prints for your Conair equipment may be ordered through the Customer Service or Parts Department for a nominal fee. Most manuals can be downloaded free of charge from the product section of the Conair website.

[www.conairgroup.com](http://www.conairgroup.com)

## We're Here to Help

Conair has made the largest investment in customer support in the plastics industry. Our service experts are available to help with any problem you might have installing and operating your equipment. Your Conair sales representative also can help analyze the nature of your problem, assuring that it did not result from misapplication or improper use.

## How to Contact Customer Service

To contact Customer Service personnel, call:



 **NOTE:** Normal operating hours are 8:00 am - 5:00 pm (EST). After hours emergency service is available at the same phone number.

You can commission Conair service personnel to provide on-site service by contacting the Customer Service Department.

## Before You Call...

**If you do have a problem, please complete the following checklist before calling Conair:**

- Make sure you have all model, control type and serial numbers from the serial tag, and parts list numbers for your particular equipment. Service personnel will need this information to assist you..
- Make sure power is supplied to the equipment.
- Make sure that all connectors and wires within and between control systems and related components have been installed correctly.
- Check the troubleshooting guide of this manual for a solution.
- Thoroughly examine the instruction manual(s) for associated equipment, especially controls. Each manual may have its own troubleshooting guide to help you.
- Check that the equipment has been operated as described in this manual.
- Check accompanying schematic drawings for information on special considerations.

## Equipment Guarantee

Conair guarantees the machinery and equipment on this order, for a period as defined in the quotation from date of shipment, against defects in material and workmanship under the normal use and service for which it was recommended (except for parts that are typically replaced after normal usage, such as filters, liner plates, etc.). Conair's guarantee is limited to replacing, at our option, the part or parts determined by us to be defective after examination. The customer assumes the cost of transportation of the part or parts to and from the factory.

## Performance Warranty

Conair warrants that this equipment will perform at or above the ratings stated in specific quotations covering the equipment or as detailed in engineering specifications, provided the equipment is applied, installed, operated and maintained in the recommended manner as outlined in our quotation or specifications.

Should performance not meet warranted levels, Conair at its discretion will exercise one of the following options:

- Inspect the equipment and perform alterations or adjustments to satisfy performance claims. (Charges for such inspections and corrections will be waived unless failure to meet warranty is due to misapplication, improper installation, poor maintenance practices or improper operation.)
- Replace the original equipment with other Conair equipment that will meet original performance claims at no extra cost to the customer.
- Refund the invoiced cost to the customer. Credit is subject to prior notice by the customer at which time a Return Goods Authorization Number (RGA) will be issued by Conair's Service Department. Returned equipment must be well crated and in proper operating condition, including all parts. Returns must be prepaid.

Purchaser must notify Conair in writing of any claim and provide a customer receipt and other evidence that a claim is being made.

## Warranty Limitations

**Except for the Equipment Guarantee and Performance Warranty stated above, Conair disclaims all other warranties with respect to the equipment, express or implied, arising by operation of law, course of dealing, usage of trade or otherwise, including but not limited to the implied warranties of merchantability and fitness for a particular purpose.**

## Safety Adjustments

**NOTE:** For chiller operation below 45°F {7.2°C}, the chiller's control **must** be configured properly. Contact Conair Service.

**IMPORTANT:** A correct mixture of glycol and water must be used as process coolant for operation below 45°F {7.2°C}. See *Installation section entitled, Filling the Chiller.*

**CAUTION:** At any setpoint, the possibility of freezing exists and it is the operator's responsibility to take necessary action to prevent freezing at all times.

**NOTE:** The high and low pressure switches are enclosed inside the same module.

To ensure safe and efficient operation at lower setpoints, adjustments of the low pressure switch from factory settings is required. The table below lists the appropriate settings.

Operating Temperature	Low Cut In	Low Cut Out
45°F	35#	25#
40°F	30#	20#
35°F	25#	16#
30°F	20#	12#

The low pressure switch serves as the mainline defense against freezing. It shuts down the chiller if the coolant temperature ever decreases to its setting.

To adjust a mechanical low pressure switch:

- 1 Disconnect and lockout the main power supply.** 
- 2 Remove the chiller's right-side panel,** as viewed from the control.
- 3 Locate the low pressure switch** within the top portion of the chiller's cabinet.



- 4 Turn the low pressure cut-in and cut-out adjustment screws found on the top of the low pressure switch,** according the operating temperature located on the chart above.

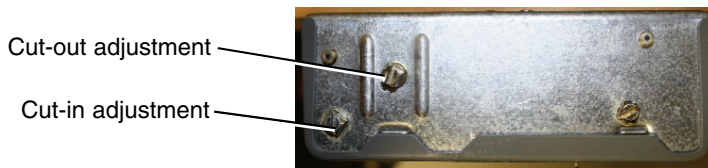

- 5 Replace the chiller's right-side panel and reapply main power.**



# Water Quality Control

Insufficient or improper water treatment can damage the EarthSmart ECM Chiller. A certified water treatment specialist should be consulted for your particular application. It is the owner's responsibility to prevent damage from foreign material or inadequate water treatment.

The two main points to consider for water treatment in chillers are:

- **Corrosion**
- **Organism growth**

Proper chemical treatment will control pH levels and algae growth.

# Chiller Capacity and Derate Chart

 **NOTE:** For chiller operation below 45°F {7.2°C}, the chiller's control **must** be configured properly. Contact Conair Service.

Ambient conditions affect air-cooled chiller operation and capacity. Standard rating is at 95°F {35°C} entering air temperature. For ambient air conditions greater than 95°F {35°C}, chiller derating will occur.

Standard chiller rating is 50°F {10°C} leaving water. For all other temperature settings, output tonnage is altered as follows:

**IMPORTANT:** A correct mixture of glycol and water must be used as process coolant for operation below 45°F {7.2°C}. *See Installation section entitled, Filling the Chiller.*

Output Temperature °F {°C}	Full Available % Capacity
60°F {15.5°C}	105%
50°F {10°C}	100%
45°F {7.2°C}	90%
40°F {4.4°C}	80%
35°F {1.6°C}	70%
30°F {-1.1°C}	60%
25°F {-3.8°C}	50%
20°F {-6.7°C}	40%

If operation of the chiller is less than 45°F {7.2°C}, a glycol and water mixture is required. *See Operation section entitled, Filling the Chiller.*

 **NOTE:** Models must be positioned so that the condenser air inlet is no warmer than 95°F {35°C} and the condenser air outlet is not blocked or restricted in any way.

 **NOTE:** Locate models away from heat producing equipment. These items will affect ambient air conditions and the performance of the chiller.

# Pressure-Temperature Chart for R-134A Refrigerant

Refrigerant Pressure (PSIG)	Saturated Temperature
5	-3°F {-19.4°C}
10	7°F {-13.9°C}
15	15°F {-9.4°C}
20	22°F {-5.5°C}
25	29°F {-1.6°C}
30	35°F {1.6°C}
35	40°F {4.4°C}
40	45°F {7.2°C}
45	50°F {10°C}
50	54°F {12.2°C}
55	58°F {14.4°C}
60	62°F {16.7°C}
65	66°F {18.9°C}
70	69°F {20.5°C}
75	73°F {22.7°C}
80	76°F {24.4°C}
85	79°F {26.1°C}
90	82°F {27.7°C}
95	85°F {29.4°C}
100	88°F {31.1°C}
105	90°F {32.2°C}
110	93°F {33.8°C}
115	96°F {35.5°C}
120	98°F {36.6°C}
125	100°F {37.7°C}
130	103°F {39.4°C}
135	105°F {40.5°C}
140	107°F {41.6°C}
145	109°F {42.7°C}
150	112°F {44.4°C}
155	114°F {45.5°C}
160	116°F {46.6°C}
170	120°F {48.8°C}
180	123°F {50.5°C}
190	127°F {52.7°C}
200	130°F {54.4°C}
210	134°F {56.6°C}
220	137°F {58.3°C}
230	140°F {60°C}

 **NOTE:** These pressure/temperature relationships are in an “At-Rest”, saturated condition. For example, if the unit has been in a warehouse at 40°F {4.4°C} and it is brought to a room where it is 80°F {26.7°C}, it may require a few hours for the unit to warm and the pressure to rise to the surrounding ambient conditions.

# RTD Resistance Chart

You can use the following chart to determine if you need to replace your RTD.

Temp °F	+ 0	+ 1	+ 2	+ 3	+ 4	+ 5	+ 6	+ 7	+ 8	+ 9
<b>0</b>	93.0334	93.2517	93.4699	93.6881	93.9063	94.1244	94.3425	94.5605	94.7786	94.9965
<b>10</b>	95.2145	95.4324	95.6503	95.8681	96.0859	96.3036	96.5214	96.7390	96.9567	97.1743
<b>20</b>	97.3919	97.6094	97.8269	98.0444	98.2618	98.4792	98.6966	98.9139	99.1312	99.3485
<b>30</b>	99.5657	99.7829	100.000	100.217	100.434	100.651	100.868	101.085	101.302	101.519
<b>40</b>	101.736	101.953	102.169	102.386	102.603	102.820	103.036	103.253	103.469	103.686
<b>50</b>	103.903	104.119	104.335	104.552	104.768	104.985	105.201	105.417	105.633	105.849
<b>60</b>	106.066	106.282	106.498	106.714	106.930	107.146	107.362	107.578	107.794	108.009
<b>70</b>	108.225	108.441	108.657	108.872	109.088	109.304	109.519	109.735	109.950	110.166
<b>80</b>	110.381	110.596	110.812	111.027	111.242	111.458	111.673	111.888	112.103	112.318
<b>90</b>	112.533	112.748	112.963	113.178	113.393	113.608	113.823	114.038	114.253	114.468

Temp °F	+ 0	+ 1	+ 2	+ 3	+ 4	+ 5	+ 6	+ 7	+ 8	+ 9
<b>100</b>	114.682	114.897	115.112	115.326	115.541	115.755	115.970	116.184	116.399	116.613
<b>110</b>	116.828	117.042	117.256	117.470	117.685	117.899	118.113	118.327	118.541	118.755
<b>120</b>	118.969	119.183	119.397	119.611	119.825	120.039	120.253	120.466	120.680	120.894
<b>130</b>	121.107	121.321	121.535	121.748	121.962	122.175	122.389	122.602	122.815	123.029
<b>140</b>	123.242	123.455	123.668	123.882	124.095	124.308	124.521	124.734	124.947	125.160
<b>150</b>	125.373	125.586	125.799	126.011	126.224	126.437	126.650	126.862	127.075	127.288
<b>160</b>	127.500	127.713	127.925	128.138	128.350	128.563	128.775	128.987	129.200	129.412
<b>170</b>	129.624	129.836	130.049	130.261	130.473	130.685	130.897	131.109	131.321	131.533
<b>180</b>	131.744	131.956	132.168	132.380	132.592	132.803	133.015	133.227	133.438	133.650
<b>190</b>	133.861	134.073	134.284	134.496	134.707	134.918	135.130	135.341	135.552	135.763

# Overhead Plumbing Details

Overhead piping installations above process connections require installing a check valve in the “To Process” line and a 12 inch {305 mm} riser with a check valve and vacuum break in the “From Process” line to prevent siphoning when shutting down the chiller. Install a vent tube at 12 inches {305 mm} above the highest system point to prevent over pressurization. Maximum height of piping above process connections is 25 ft {7.6 m}.

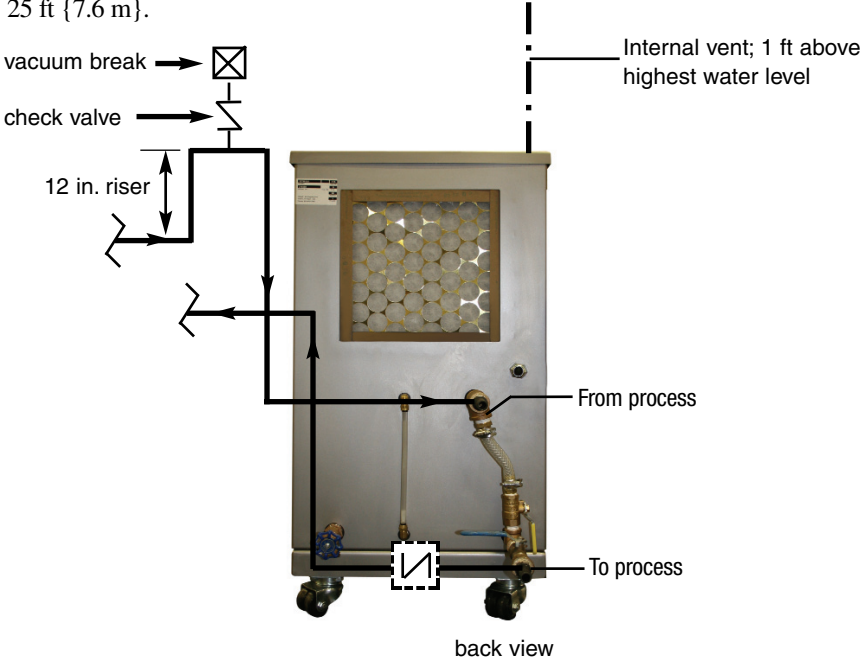

# Electrical Schematic

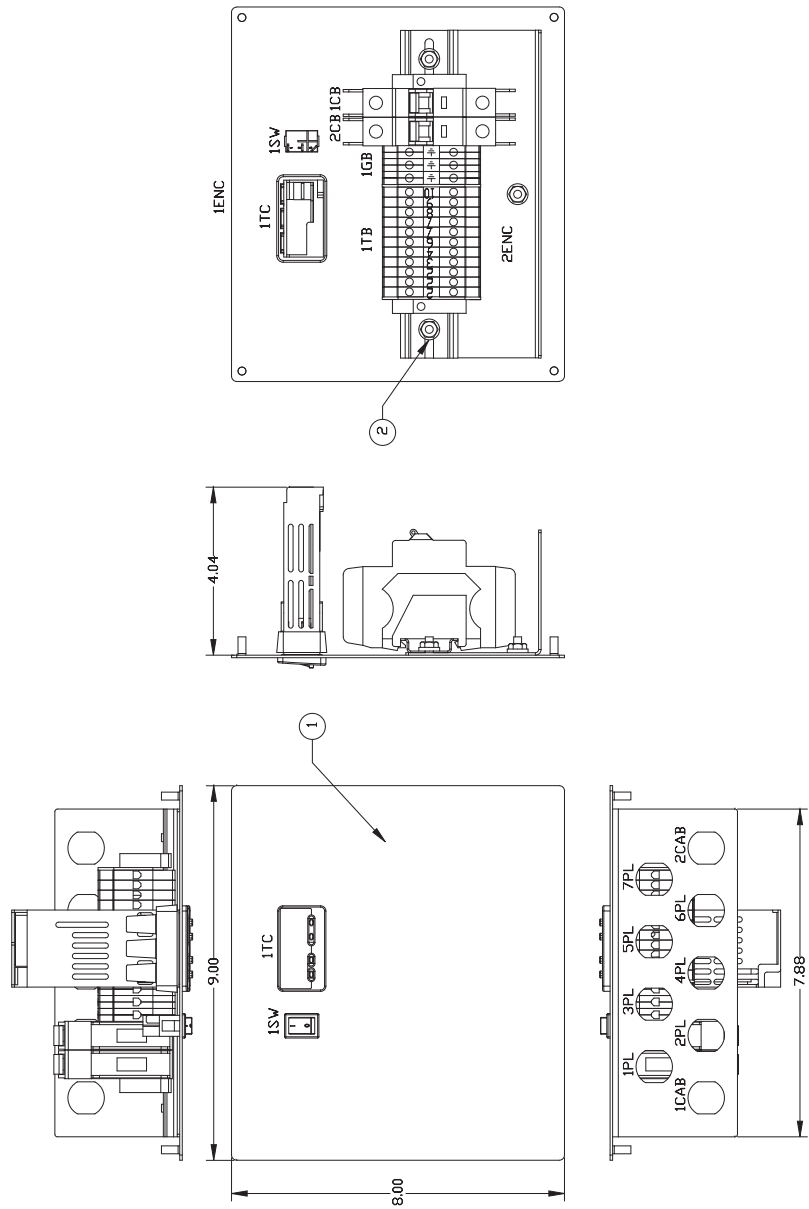

# Control Setup

1/32 DIN Watlow SD controller Setup Sheet

Enter the following parameters

Menu	Parameter	Description	Setting
Set Up Page	Sen	Input sensor type	RTD
up & down for	C-F	Temperature Units (degrees)	F
3 seconds	S.dec	Temperature Decimal Places	0
	IS.en	Infosense	no
	SP.Lo	Set Point Low Limit	40.0
	SP.hi	Set Poing High Limit	65
	Ftr.e	Input Filter	Both
	Flt.r	Filter value - Seconds	5
	Ot1	Output 1 function	heat
	Ctrl	Control Method 1	fb
	Ftb1	Cycle time 1	10
	PL 1	Power Limit 1	100%
	PSL1	Output Power Limit Sacle Low 1	0%
	PSH1	Output Power Limit Sacle High 1	90%
	nLF1	Output Non-Linear Function 1	Off
	Ot2	Output 2 Function - SP deviation	dE.AL
	hys2	Alarm Hysteresis 2	1.5F
	Lgc2	Alarm relay state on alarm - open	Al o
	Lat2	Alarm 2 latching	nLat
	dSP2	Alarm 2 Message	on
	ACLF	AC line frequency	60
	Unit	Units of Measurement	SI
	I.Err	Input error latching	nLat
	FAIL	Input Error Failure Mode	bPLS
	Man	Manual Error Level	0%
	dSP	Active Displays	nor
	rP	Ramping Mode	off
	LOC	Security Lockout	3
Programming	Adv and INF keys 6 seconds		
	P1	Temperature Units - C-F	F
	P2	Low Temp Dev. alarm - A2.Lo	-4
	P3	High Temp dev Alarm - A2.HI	20
	P4	Proportional Band Hot Gas - pb.ht	3
	P5	Intergral Hot Gas - It.ht	3.4
	P6	Derivative - dE.ht	0.1

# Plumbing Schematic

